

High-Speed
BOX Camera

for Sports
QDCAM®

Global Shutter
Multi-Camera Synchronizing Exposure System
Multi-Camera High-Speed Video
Synchronizing Playback System



High-Speed Box Camera for Sports QDCAM®

Affordable High-Speed Box Camera

Excellent image quality

Remote camera/lens control

High-precision multi-camera synchronized shooting



Features

High-speed shooting **4x speed**



With 1920 × 1080 pixel FHD resolution, 4 × speed shooting at 239.8 fps or 200 fps is possible. In combination with a slow-motion server, smooth slow-motion playback can be performed, making high-precision sports analysis possible.

Global shutter CMOS image sensor

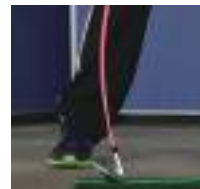

Rolling shutter shooting

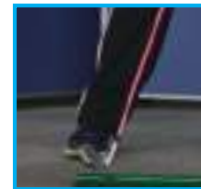

Global shutter shooting

QDCAM

Global shutter image sensor provides excellent picture without rolling shutter distortion in a quick moving object. Global shutter sensor is suitable for sports shooting.

High-resolution shooting **4K**

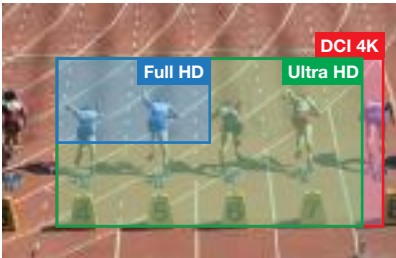

At a frame rate of 59.94 fps or 50 fps, 3840 × 2160 pixel UHD resolution shooting is possible. At 24 fps, 4096 × 2160 pixel DCI 4K resolution shooting is possible.

Micro four thirds lens system



The adoption of micro four thirds allows the use of inexpensive, high-quality lenses. It also allows the use of bright lenses that are effective for high-speed shutter shooting under nighttime game lighting. The iris and focus can also be controlled remotely by electronic control using electrical contacts.

Optical transmission using a fiber optic camera cable



You can use optical transmission system using SMPTE standard fiber optic camera cables which are installed in stadiums and other facilities frequently used for sports broadcasting.

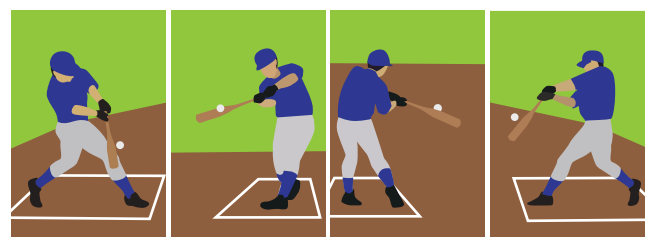

Multi-camera synchronizing exposure system

The exposure timing of multiple cameras can be synchronized with high-precision without being affected by differing camera cable lengths. This allows the video from multiple cameras to be frozen simultaneously, preventing any timing deviation when switching to a video from a different angle. This also can improve the calculation accuracy of automatic sports referee systems which use images from multiple cameras. (Japan patent No. 6635635)

Remote camera operation using a LAN/IP network



Box cameras for city view, weather view or other purpose, installed in a distance, can be controlled remotely by PC through an IP network.

Multi-camera high-speed video synchronizing playback system

When linked with a QDVS recorder/player, high-speed video from multiple angles can be synchronized for slow-motion playback or frame-by-frame playback, allowing the video to be checked for sports referee calls.



QDCAM[®] for Sports



Affordable high-speed cameras **allow variety of slow-motion views.**

Sports Broadcasting and Program Production

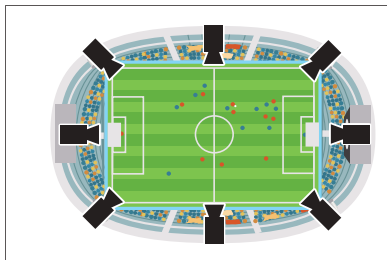

Affordable cameras are **ideal for multi-angle video or free viewpoint video production** that requires large number of cameras.



Can also be used for UHD program production.

Video Assistant Referee

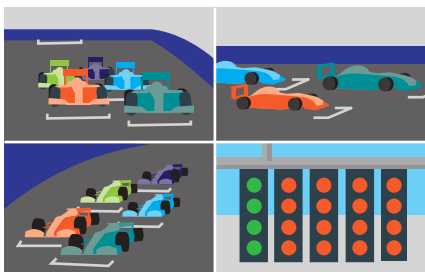

Example: Race start and goal scenes

High-precision **synchronous high-speed video shooting** and **synchronized playback** for checking the timing of a wide range of movements.

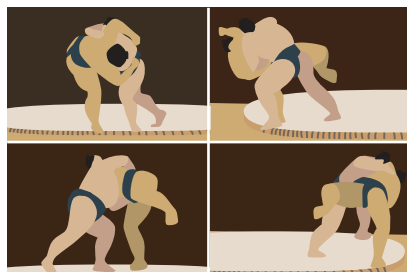

Example: Martial arts game scenes

Automatic Judgement System



Synchronizing shooting with high-precision **improves the calculation accuracy of automatic judgement system.**

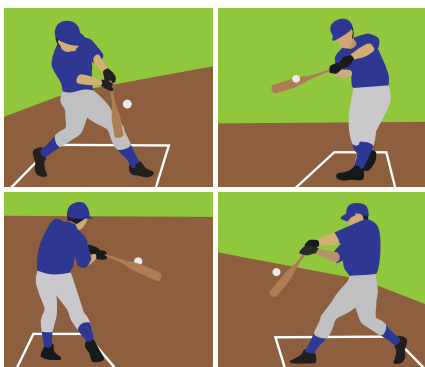

A wide range of analysis is possible using high-speed shooting synchronized with high-precision.

Sports Analysis and Coaching

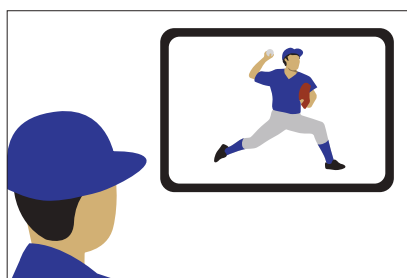

Delayed display of video with QDVS **allows athletes to check their own form.**



Team formations and player **movements can be analyzed for use in coaching.**

Camera Interface

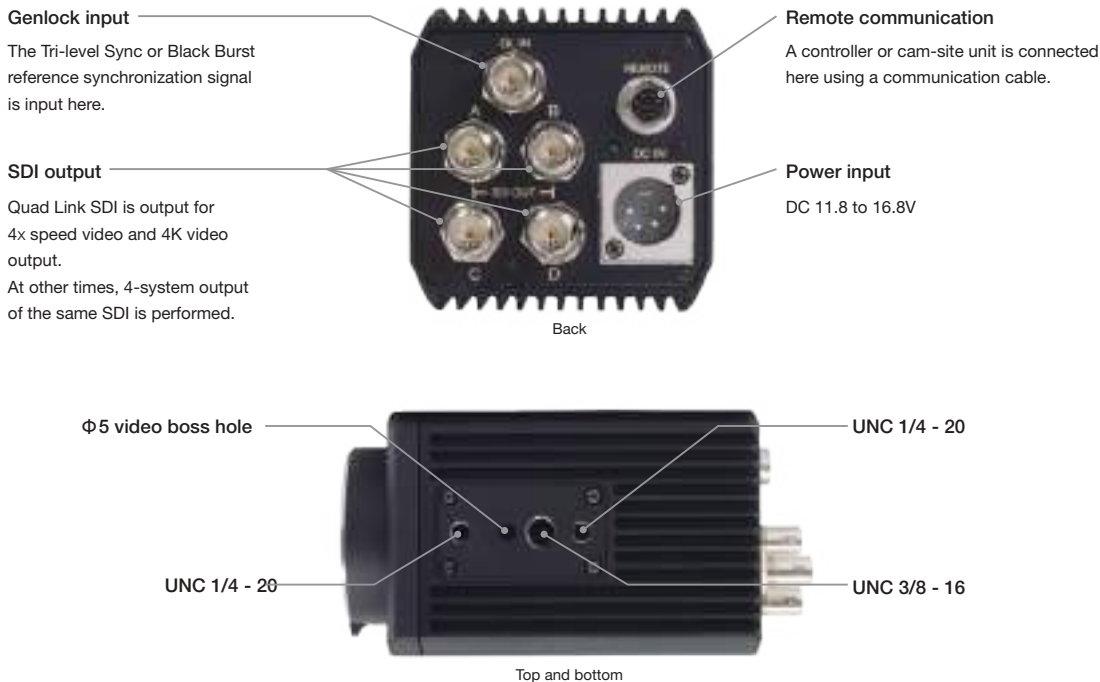

Lens and Camera Communication Control Items

● Lens control

Focus	Iris	Zoom
Near ↔ Far	Open ↔ Close	Wide ↔ Tele-photo * Power zoom lens only

● Camera control

Video Format	DCI24/DCI23/UHD60/UHD59/UHD50/UHD24/UHD23/FHD240/FHD239/FHD200/FHD60/FHD59/FHD50/FHD24/FHD23/FHD59i/FHD50i
Step Shutter	1/50, 1/60, 1/100, 1/120, 1/125, 1/200, 1/250, 1/400, 1/500, 1/750, 1/1000, 1/2000, 1/3000, 1/4000, 1/6000, 1/8000, 1/12000 sec
Synchro-Shutter	1/60.2 to 1/4096 sec
Gain Adjustment	-6 to +36 dB (1 dB steps)
Color Gain Adjustment	R_GAIN, G_GAIN, B_GAIN
Black Level Adjustment	MASTER PEDESTAL, R_PED, G_PED, B_PED
Automatic Iris	ON/OFF
Automatic Iris Response Speed	0~15
Target Luminance Level Adjustment	-12 to +12 dB (1 dB steps)
Gamma	BT.709 standard gamma * Fine adjustments are possible. BT.2100 hybrid log gamma (HLG)
Knee Mode	MANUAL/AUTO
Knee Point	100%/95%/90%/85%/80%/75%/OFF
Detail Enhancement	0 (OFF) to 7 (high)
Noise Reduction	OFF/ON
Flicker Cancel	50 Hz power lighting / 60 Hz power lighting / OFF
White Balance Mode	AUTO/MANUAL/PRESET
Manual White Balance	MAIN/CH A/CH B/CH C (Take & Load)
Preset White Balance	Color temperature 2800 to 10000K (100K steps)
Color Gamut	BT.709, BT.2020
6-Axis Color Correction	Hue and saturation of each color axis: magenta, red, yellow, green, cyan, and blue
Image Angle Selection for 4x Speed Shooting	CENTER ROI/FULL SCREEN
Scene Memory	Camera setting data can be stored to 3 sets of scene memories and can be loaded from one of scene memories.
Color Bar	ON/OFF
Blemish Compensation	Automatic blemish detection and automatic blemish compensation

ROP (Camera Controller)

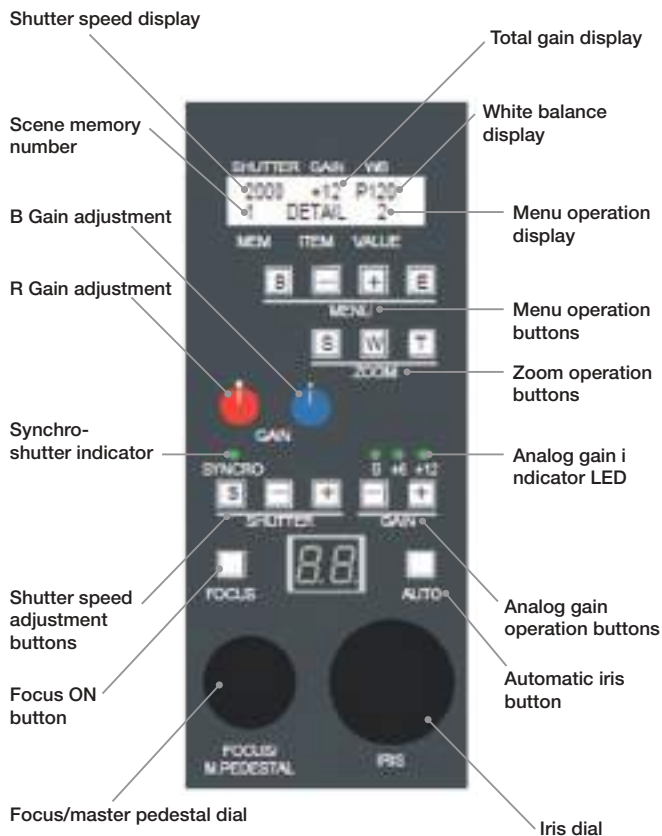

Basic Camera Functions

6-Axis Color Correction

With the QDCAM camera, it is possible to adjust the hue and saturation independently for each of 6 axis colors as shown by the vector scope, specifically red, magenta, blue, cyan, green, and yellow.

This 6-axis color correction is useful in cases such as when shooting with cameras from multiple manufacturers, or when color differences cannot be identified when the image is changed by the switcher.

In addition, it is possible to change the overall Chroma Level by increasing or decreasing the saturation for all 6 colors without changing the hue.

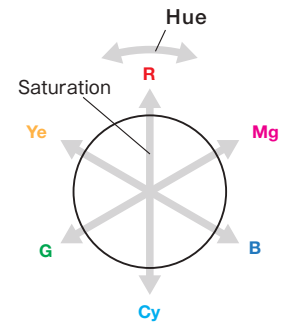

View Angle Mode for 4X Speed Shooting

When shooting at 4X speed such as 240fps, 239.8fps and 200fps frame rate, 2.1million pixel signals out of a total 8.8million pixels are read out. Normally, 2.1million pixel signals in the center of the image sensor are read out to provide high-quality, high-speed video without jaggy. (Center ROI mode)

However, you can also use Full Screen mode, which reads out 2.1million pixel signals by thinning out evenly from the full screen, to take a wider image.

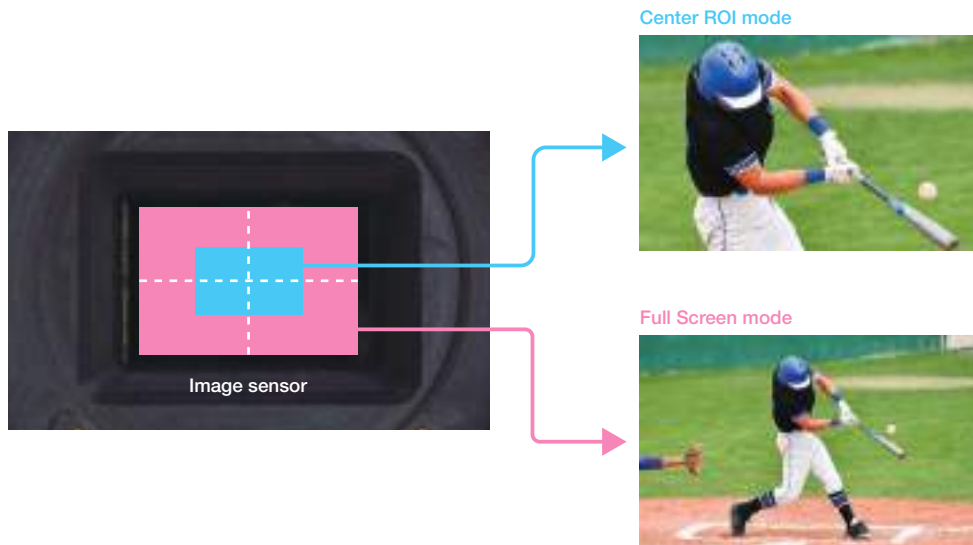

● Example of field of view height when using a micro four thirds lens with focal length $f=42.5$ mm

Mode	Vertical view angle	Field of view height		
		Distance to subject 7m / 20ft	Distance to subject 15m / 49ft	Distance to subject 30m / 98ft
Center ROI	4.66°	0.57m / 1.9ft	1.22m / 4.0ft	2.44m / 8.0ft
Full screen	9.30°	1.14m / 3.7ft	2.44m / 8.0ft	4.88m / 16ft

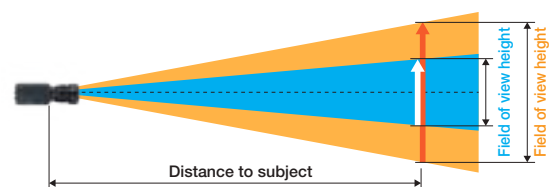

Example of System Configuration

Basic System

A simple system can be used as long as it is within the range that can be connected using a 3G-SDI coaxial cable with the maximum allowable length.

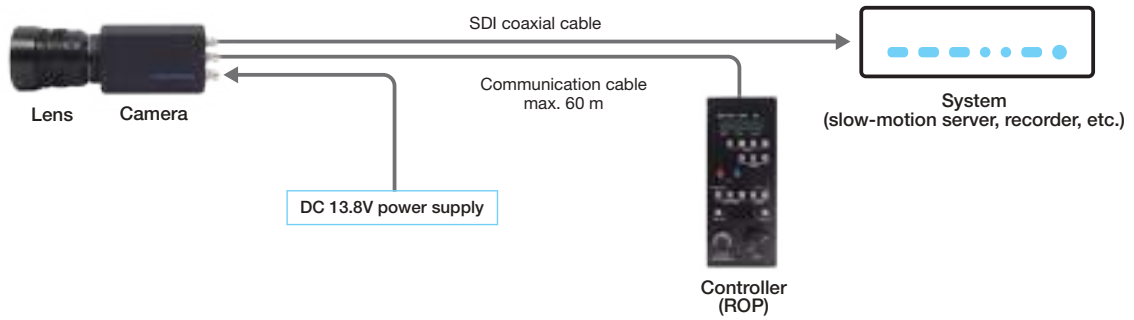

Sample uses

- Sports Judgement
- Sports analysis
- Video production
- ...etc.



Fiber Optic Camera Cable Transmission System

When operating in a stadium for sports broadcasting, or in cases where transmission over a large distance is required such as when using an OB van, optical transmission system can be used.

When supplying power to the camera via the optical camera cable, the maximum camera cable length is 500 m. When power is supplied directly to the cam-site unit, the maximum length can be extended to 2,000 m.

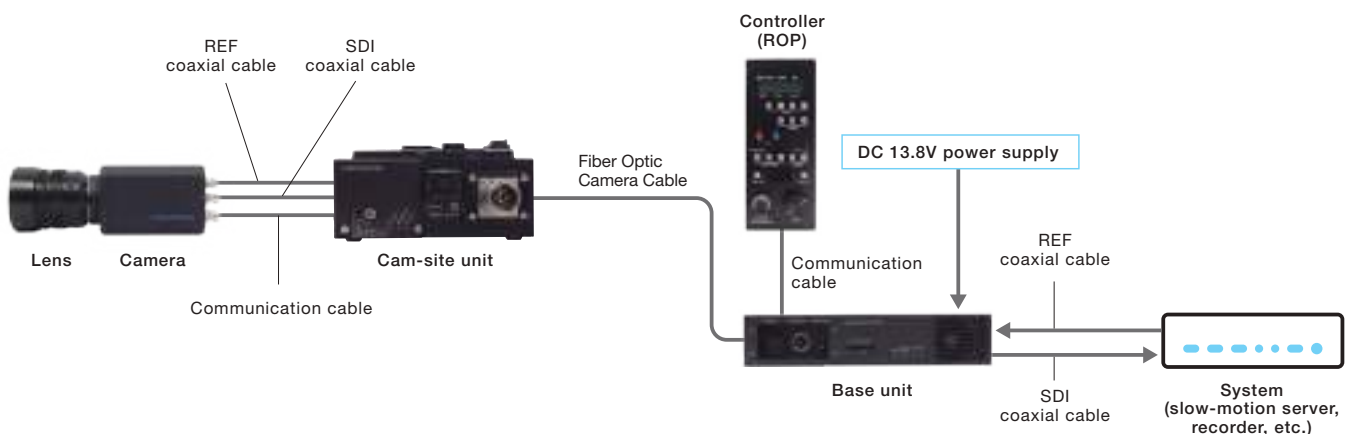

Examples of uses

- Sports Broadcasting
- Sports Judgement
- ...etc.



At stadiums



In sports arenas



Live golf broadcasts

Multi-Camera Central Control System

Remote control via an IP network is possible by performing LAN conversion of the RS-422 communication line used for camera and lens control. A QDCAM control app for Windows PCs is available, and up to 99 cameras and lenses can be controlled from a single Windows PC. The QDCAM control app allows independent control of each camera, as well as central control of a specified camera group. Cameras can also be identified by IP address, and controlled using the QDCAM controller (ROP).

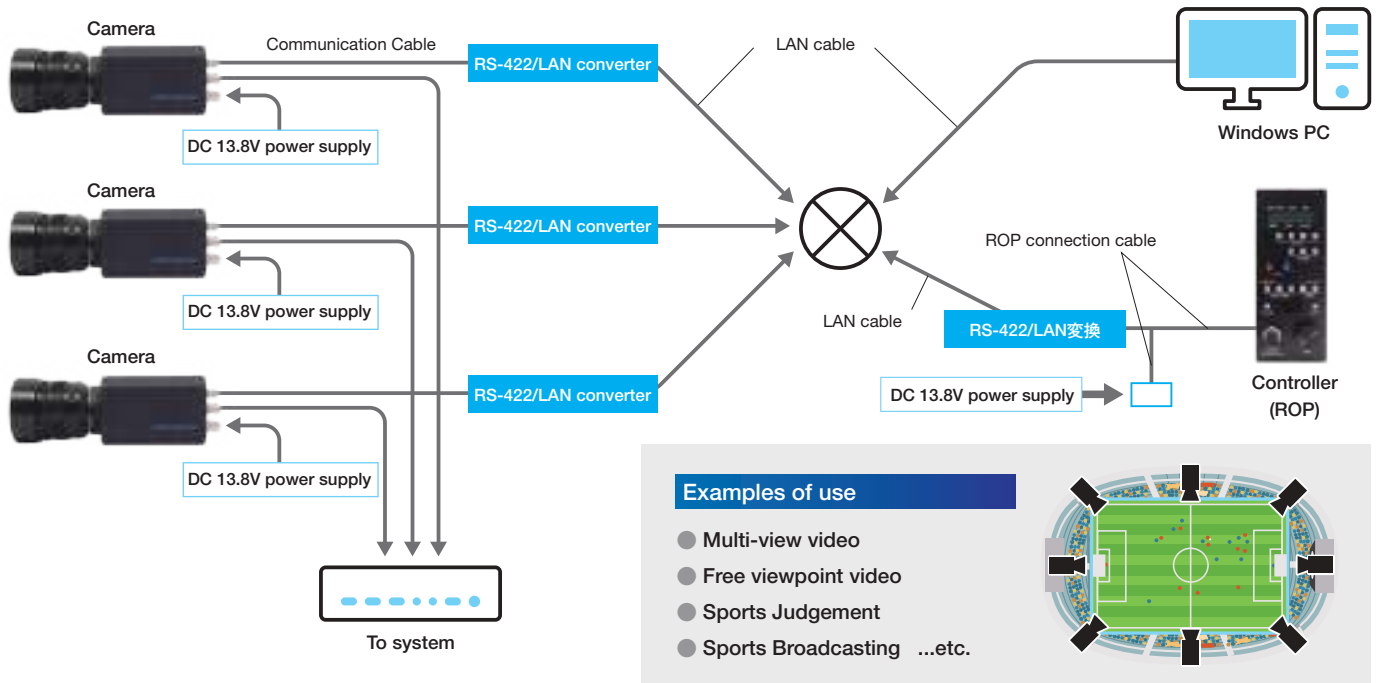

IP Network Remote Control System

An information camera, such as weather view camera, city view camera or traffic camera, which is installed in a distance from operation center, can be controlled via an IP network. In the same way as the multi-camera central control system, the QDCAM control app is used. When a video encoder is used, the video can also be transmitted using the same network.

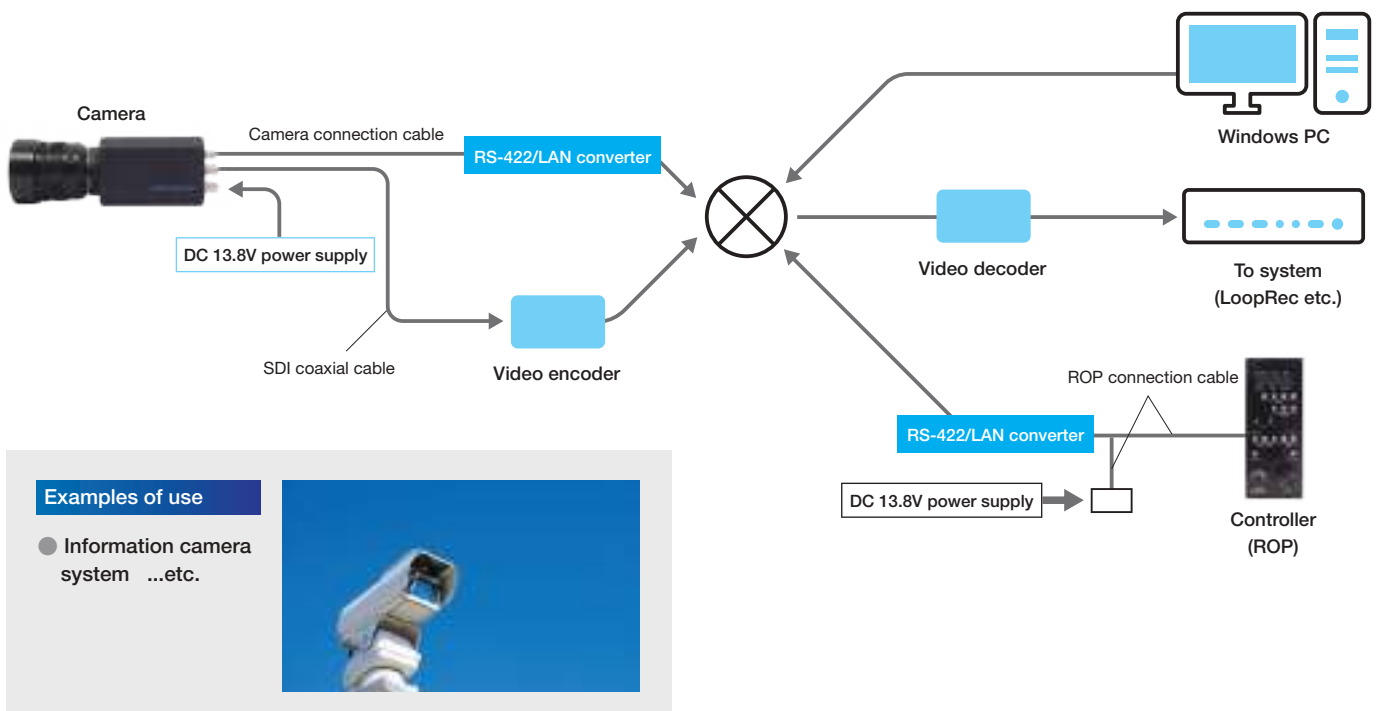

Slow-Motion Video Production

Connecting to a Video Production Server

By connecting to a video production server or similar device, it is possible to perform slow-motion playback of live sports and to edit the highlights.



Connecting to the Slow-Motion Recorder/Player QDVS

Loop recording is performed using the QDVS-1000 internal memory, and when a scene which you want to play again occurs, you can switch to playback mode and perform slow-motion playback, frame-by-frame playback, and freeze-frame display.

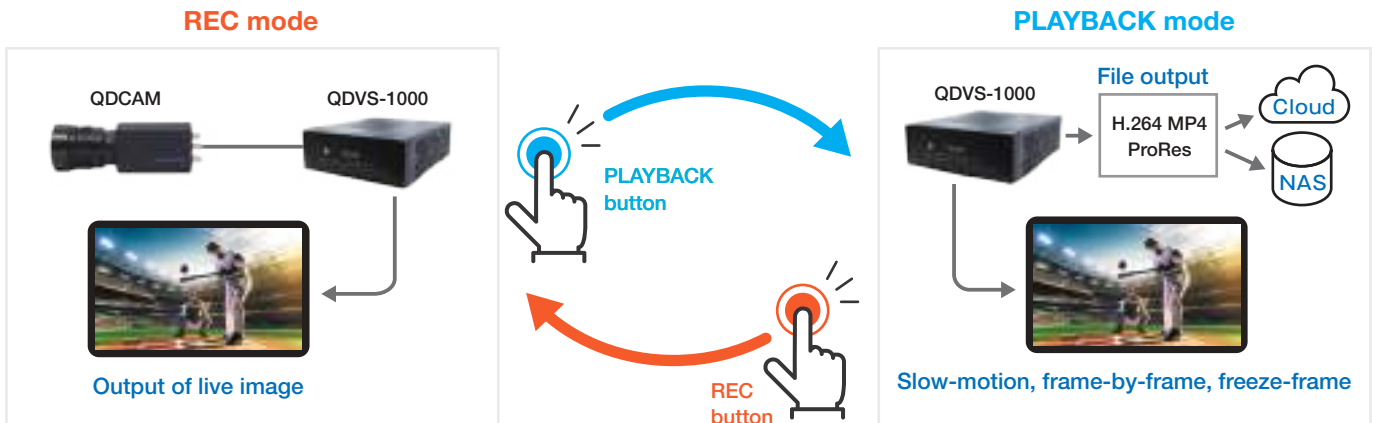

Recording to a Portable Recorder and Offline Conversion

FHD/240p high-speed video can be recorded as UHD/60p 4K video, and the video file can be converted on a PC to 4X duration FHD/60p slow-motion video.

Video is recorded at the sports site, and the recording media is brought back to the office for analysis or uploading to SNSs.

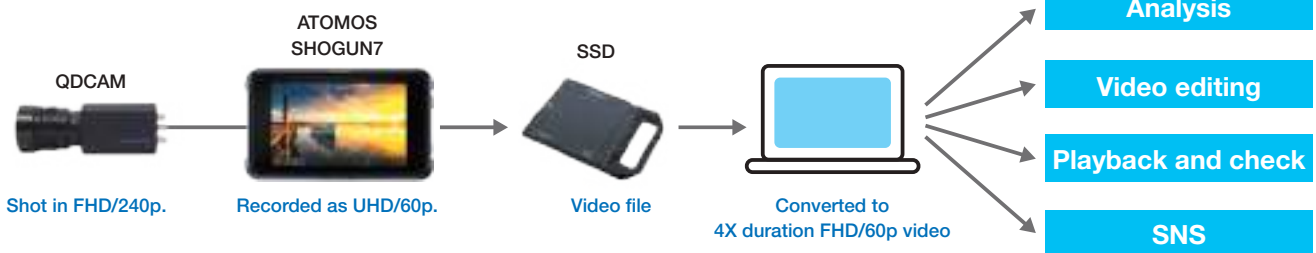

* A free conversion app is available.

Slow-Motion Recorder/Player

QDVS-1000

The QDVS-1000 slow-motion server (recording/playback switching type) captures uncompressed QDCAM 240 fps high-speed video and records it by loop-recording in internal memory. When recording is stopped, it can perform FHD 60 fps slow-motion playback, frame-by-frame playback, and freeze-frame display. The playback speed and frame-by-frame playback can be operated as needed by keyboard operations or by using the optional jog controller or T-bar.



■ Delayed display during recording → Slow-motion display after recording is stopped → Frame-by-frame display



<p>During recording</p> <p>With live delayed display, checking immediately after the swing</p>	<p>During playback</p> <p>Slow-motion playback when user wants to check</p>	<p>During playback</p> <p>Frame-by-frame playback for more detailed checking</p>
<p>During recording</p> <p>Setting the IN point when subject enters the frame</p>	<p>During playback</p> <p>Recording stop, jump to IN point, and slow-motion playback</p>	<p>During playback</p> <p>Frame-by-frame playback at goal line</p>

While recording, both live display and delayed display are possible. A wide range of display settings are available that support all of the following: recording time, operation when recording is stopped while recording with delayed display, file transfer destination after encoding, still image settings, settings for divided memory use, and live display, as well as overlay display of a still image, drawn lines, or other image during slow-motion playback.

■ MP4 encoding function

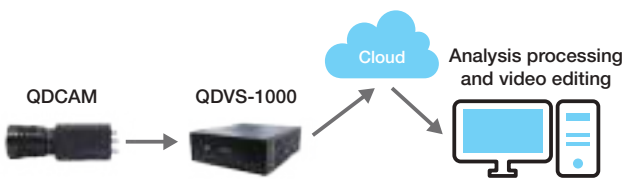

A preset time of recorded video, or the time between the IN and OUT points, can be encoded in H.264-MP4 or MOV format and transferred to NAS or cloud storage. In addition to slow-motion playback, files can also be created for editing and analysis purposes.

■ Multi-camera simultaneous recording function

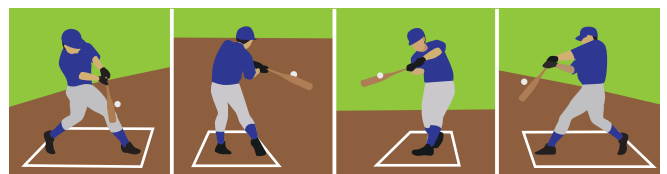

Simultaneous recording is supported. It is possible to use multiple sets of QDCAM and QDVS to synchronize recording and playback. Even with frame-by-frame playback of multi-angle high-speed video, multiple images can be displayed with precision synchronized timing.

■ Wide range of display functions



Zoom-in display during playback

The magnification function can be used during playback for a zoomed-in display centered on the desired location.

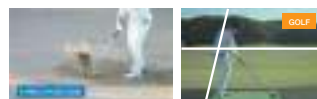

Picture overlay

Picture data can be overlaid to display sponsor logo, coaching assist lines, etc.

■ QDVS Series lineup

- QDVS-1000 25-second recording HDMI output
- QDVS-3000 5-minute recording HDMI output
- QDVS-5000 45-second recording, 10-bit support SDI output



- MSR-QDVS1K-W2UH Rack-mounting kit

System Functions

Multi-Camera Synchronizing Exposure System

Consider a live sports broadcast system which transmits signals for multiple cameras using camera cables such as that shown below. With ordinary genlock synchronization, control is performed to align the video signal phases at the time of output from the base unit which is connected to the switcher. As a result, the exposure timing of each camera will be deviated due to the different camera cable lengths. For example, when a signal is transmitted 1,000 m using a fiber-optic cable, a delay of approximately 5 μ s occurs. As a result, the video signal becomes deviated by 5 μ s due to the different camera cable length, or else the synchronization control signal becomes deviated. This produces deviation of 5 μ s or more in the camera exposure timing.

However with QDCAM, the transmission delay time is measured when the base unit power is turned ON and when a camera cable is connected. After a dozen or so seconds for processing, the timing of synchronization control signal transmission will be advanced based on the measured delay time. This ensures that the synchronization signal phase is identical on the camera side, and enables fully synchronized exposure timing. (patent pending)

This technology prevents deviation in timing when freezing the frame and when switching to another angle with multi-angle video. It also improves the calculation accuracy of systems which automatically make referee calls based on video images from multiple cameras.

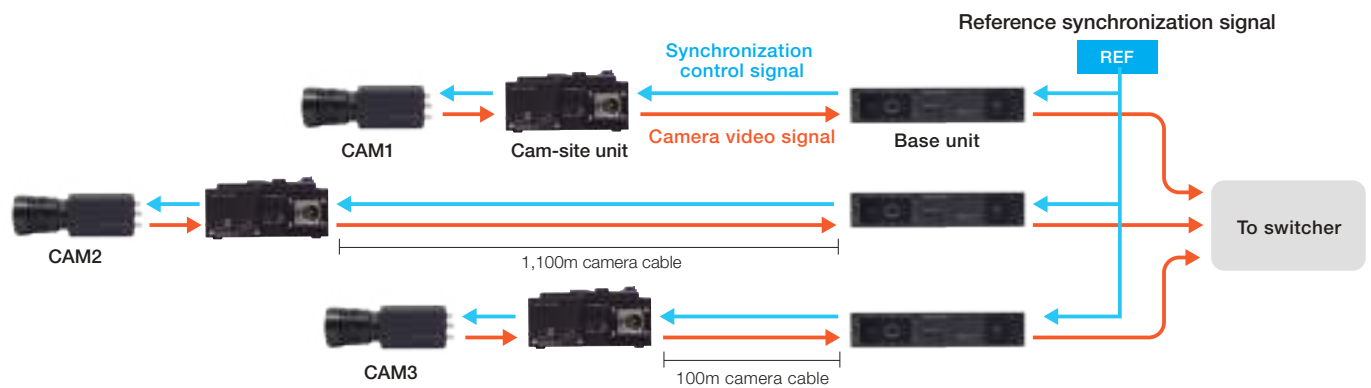

Multi-Camera High-Speed Video Synchronizing Playback System

Linking a QDCAM camera and QDVS-1000 recorder/player allows synchronized slow-motion playback and frame-by-frame playback of high-speed video from multiple cameras. Because the camera exposure timing is fully synchronized, the timing matches even during frame-by-frame playback from multiple angles. As a result, it is possible to monitor for false starts in speed events, and check video for combat sports and other events.

With the QDVS-1000, encoding is performed with matching start frames, and the video files can be sent to external storage media or a PC for use in video editing and analysis.

In the system shown in the figure below, 4 cameras are shooting 1080/240p video. Synchronized shooting is possible at each camera using the reference synchronization signal (REF), and a common trigger signal is supplied. When each camera receives the trigger signal, it outputs high-speed video with a trigger pattern and supplies it to a QDVS-1000. When each QDVS-1000 detects the trigger pattern, it begins slow-motion playback from the specified time (specified number of frames) earlier based on the trigger pattern time position. Because one slow-motion controller can perform slow-motion playback, frame-by-frame playback, and freeze-frame of 4 QDVS-1000, it is possible to check video with matching time positions (frame numbers) in frame-by-frame or freeze-frame playback even in video which combines the images from 4 cameras.

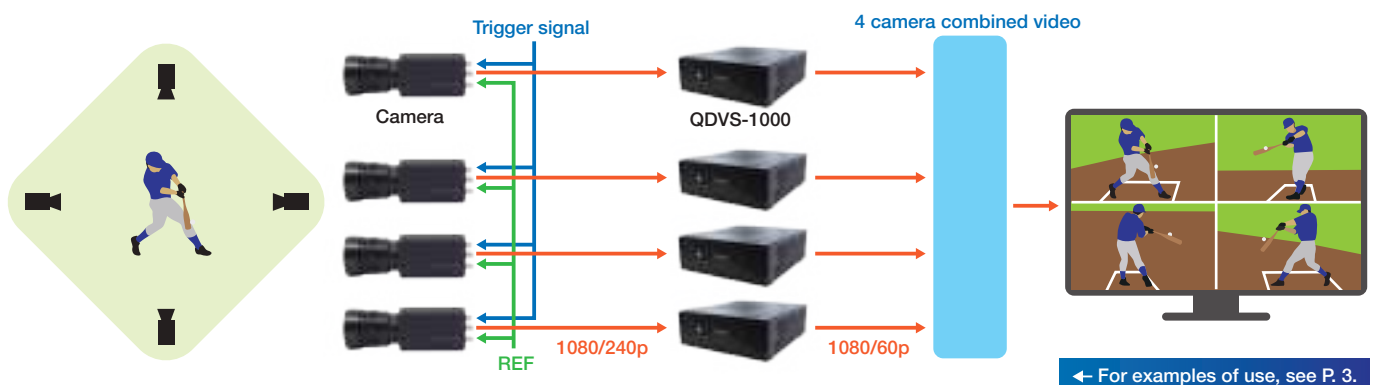

← For examples of use, see P. 3.

Products and Accessories



QDCAM Camera

- Box camera
Model ME-BXC-CM100

* Lens and AC adapter are sold separately.



QDCAM Controller

- ROP (operation panel)
Model ME-BXC-RC100

* With 5 m communication cable and connector



QDCAM Transmission System

- Cam-site unit
Model ME-BXC-CU100

* With 3 m communication cable /
 Optical camera cable is sold separately and
 includes installation bands.
 Can also be used as an ordinary 12G-SDI
 video transmission system.



QDCAM Transmission System

- Base unit
Model ME-BXC-BU100

* Optical camera cable and AC adapter are
 sold separately.
 Rack mounting kit MSR-BU100-W1UH:
 Can also be used as an ordinary 12G-SDI video
 transmission system.



Communication Cables

- 3m
Model ME-BXC-CC3M
- 5m
Model ME-BXC-CC5M
- 10m
Model ME-BXC-CC10M
- 30m
Model ME-BXC-CC30M
- 50m
Model ME-BXC-CC50M



RS-422/LAN Converter Connection Cable

- Camera connection cable
Model ME-BXC-SCA
- ROP connection cable
Model ME-BXC-SCB

* For connecting a MOXA NPort5130



Slow-Motion Recorder/Player



- QDVS recording and
 playback system
 Recording time: 25 sec
Model ME-QDVS-1000

* Includes keyboard, special compact keyboard,
 and mouse

- QDVS recording and
 playback system
 Recording time: 900 sec
Model ME-QDVS-3000

- QDVS recording and
 playback system
 Recording time: 45 sec 422 10-bit
Model ME-QDVS-5000

* Rack mounting system MSR-QDVS1K-W2UH: 27,500JPY (tax inclusive)



Capture Card Supporting Quad 3G-SDI

- PC video capture card
Model MS-SC710N1-12GSDI-QC

* Includes Windows drivers.



Musashi Controller Connection Kit

- USB-RS422 converter & cable
Model ME-QDVS-OP422

Peripheral Devices

Jog Shuttle/ Slow-Motion Controller

- Contour Design
 ShuttleExpress
 IM/SX Shuttle



T-Bar Slow-Motion Controller



- MUSASHI
 MDC-70T



- MUSASHI
 MDC-22

Monitor with Recording Functions



- SHOGUN 7
 High-brightness 7-inch



- SUMO 19
 High-brightness 19-inch



- SHOGUN STUDIO 2
 Rack-mounting support
 Simultaneous recording of 2 monitors
 is possible.

* The file conversion software can be downloaded from the MEDIAEDGE website.

Main Product Specifications

● Box camera (ME-BXC-CM100)

Image Pickup Device	1/1.1" 8.8 megapixel CMOS imaging element with global shutter
Imaging Method	Single image sensor with Bayer color configuration
Lens Mount	Micro four thirds system
Output Video Format	4096 × 2160/24p, 23.98p (Quad 1.5G-SDI) 3840 × 2160/60p, 59.94p, 50p (Quad 3G-SDI) 3840 × 2160/24p, 23.98p (Quad 1.5G-SDI) 1920 × 1080/240p, 239.8p, 200p (Quad 3G-SDI) 1920 × 1080/60p, 59.94p, 50p (3G-SDI) 1920 × 1080/24p, 23.98p (1.5G-SDI) 1920 × 1080/59.94i, 50i (1.5G-SDI)
Genlock Reference	Tri-level Sync or Black Burst
Communication Interface	RS-422 (using communication cable)
Gain Setting	-6 dB to +36 dB
Shutter Speed Setting	Shutter OFF to 1/12000 sec
Gamma Setting	BT.709 gamma / BT.2100 HLG
Color Gamut Setting	BT.709 / BT.2020
White Balance	Manual / Auto / Preset (2800K to 10000K)
Flicker Cancel	OFF / 50Hz / 60Hz
Operating Temperature	-5 to 45°C (23 to 113°F)
Operating Humidity	20 to 80% RH (Must be no condensation.)
Weight	690g (1.52 lb)
Dimensions	75 (W) × 127 (D) × 75 (H) mm (excluding protrusions) 3.0" (W) × 5.0" (D) × 3.0" (H) (excluding protrusions)
Power Voltage	DC 13.8V (DC 11.8 to 16.8V)
Power Consumption	10W (excluding power supply to lens and controller)

● Slow-Motion Recorder/Player (ME-QDVS-1000)

USB Port	USB3.0 standard	Type A × 2 on front
	USB2.0 standard	Type A × 2 on front, 4 on back
LAN Port	RJ-45	1000Base-TX × 1 Conforms to Ethernet/IEEE802.3 frame format.
Video Output	HDMI	HDMI 2.0 × 1
Operating Temperature	0 to 50°C (32 to 122°F)	
Operating Humidity	10 to 90% RH (Must be no condensation.)	
Weight	1.91 kg (4.21 lb)	
Dimensions	200 (W) × 250 (D) × 78 (H) mm (excluding protrusions) 7.9" (W) × 8.1" (D) × 3.1" (H) (excluding protrusions)	
Power Voltage	AC adapter	Input: AC 100 to 240V, 2.5 A max. Output: DC 19.5V, 9.23 A
	Main unit	Input: DC 19.5V, 9.23 A
Power Consumption	60W (during normal operation)	

● Camera Controller (ME-BXC-RC100)

Communication Interface	RS-422 (using 10-pin communication cable)
Operating Temperature	0 to 40°C (32 to 104°F)
Operating Humidity	20 to 80% RH (Must be no condensation.)
Weight	850 g (1.87 lb)
Dimensions	92 (W) × 226 (D) × 36 (H) mm (excluding protrusions) 3.6" (W) × 8.9" (D) × 1.4" (H) (excluding protrusions)
Power Voltage	DC 13.8V (DC 11.8 to 16.8V) * Power is supplied through the communication cable.
Power Consumption	1W
Accessories	5 m communication cable, cable connector, mounting bracket

● Transmission System Cam-Site Unit (ME-BXC-CU100)

Compatible Camera Cable	SMPTE 311 camera cable with SMPTE 304 connectors
Cable Length	Max. 500 m (when power is supplied to the camera through the camera cable) Max. 2000 m (when local power supply is used for the camera unit)
Operating Temperature	-5 to 45°C (23 to 113°F)
Operating Humidity	30 to 90% RH (Must be no condensation.)
Weight	1.26 kg (2.78 lb)
Dimensions	150 (W) × 150 (D) × 60 (H) mm (excluding protrusions) 5.9" (W) × 5.9" (D) × 2.4" (H) (excluding protrusions)
Power Voltage	DC 13.8V (DC 12 to 17V: when local power supply is used)
Power Consumption	14W (not including camera power supply)

● Transmission System Base Unit (ME-BXC-BU100)

Compatible Camera Cable	SMPTE 311 camera cable with SMPTE 304 connectors
Cable Length	Max. 500 m (when power is supplied to camera through the camera cable) Max. 2000 m (when local power supply is used for the camera unit)
Operating Temperature	0 to 40°C (32 to 104°F)
Operating Humidity	30 to 90% RH (Must be no condensation.)
Weight	1.60 kg (3.53 lb)
Dimensions	200 (W) × 200 (D) × 42 (H) mm (excluding protrusions) 7.9" (W) × 7.9" (D) × 1.7" (H) (excluding protrusions)
Power Voltage	DC 13.8V (DC 12 to 17V: when local power supply is used)
Power Consumption	Max. 60W (including power supply to cam-site unit and cable loss)

* Specifications may be changed without notice.

MEDIAEDGE

<https://www.mediaedge.co.jp> (Japanese)
<https://www.mediaedge-corp.com> (English)

● Head Office 23F Kobe Commerce, Industry and Trade Center Bldg.5-1-14, Hamabe-dori, Chuo-ku, Kobe, Hyogo, 651-0083 Japan Phone:+81-78-265-1551 Fax:+81-78-265-1550

● Tokyo Office 7F Muroichi Bldg.1-13-4, Muromachi, Nihonbashi, Chuo-ku, Tokyo, 103-0022 Japan Phone:+81-3-3517-1655 Fax:+81-3-3517-1657

● e-mail:osinfo@mediaedge.co.jp

©Information listed here is current as of September 2021.



E063210918001